

A

B

C

D

E

F

4

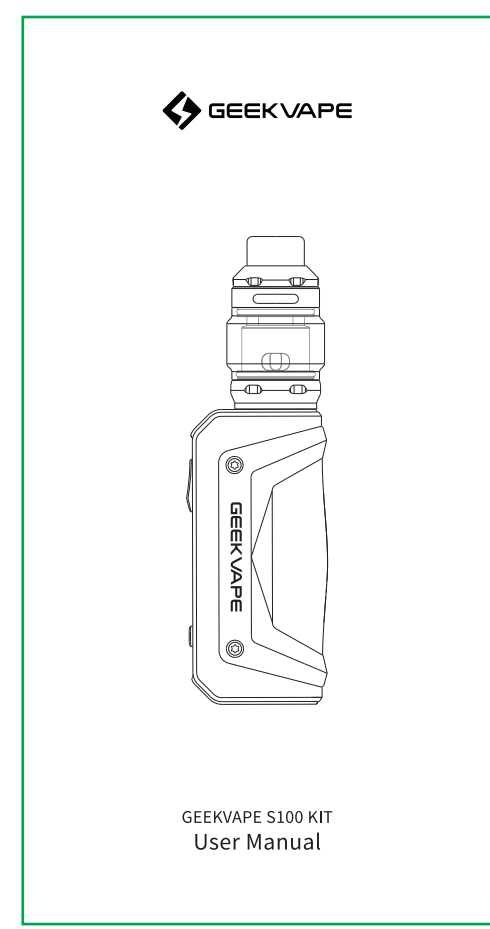

封面

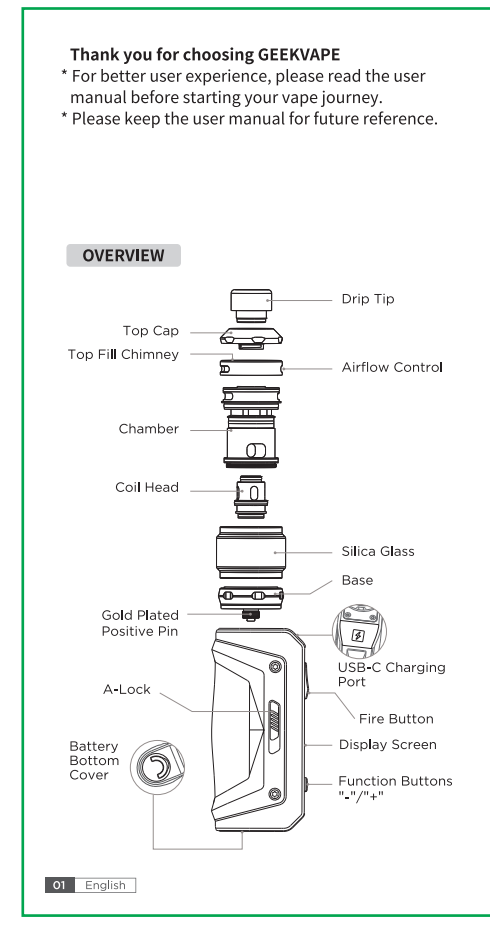

1

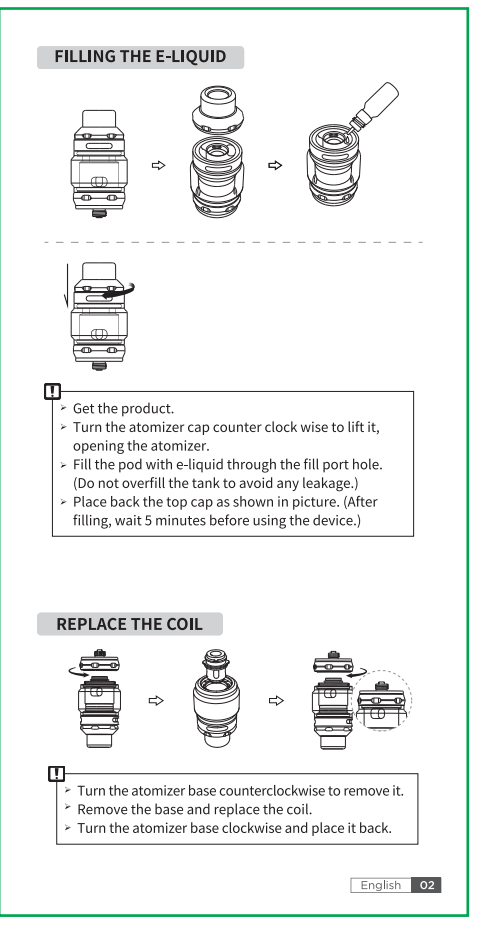

2

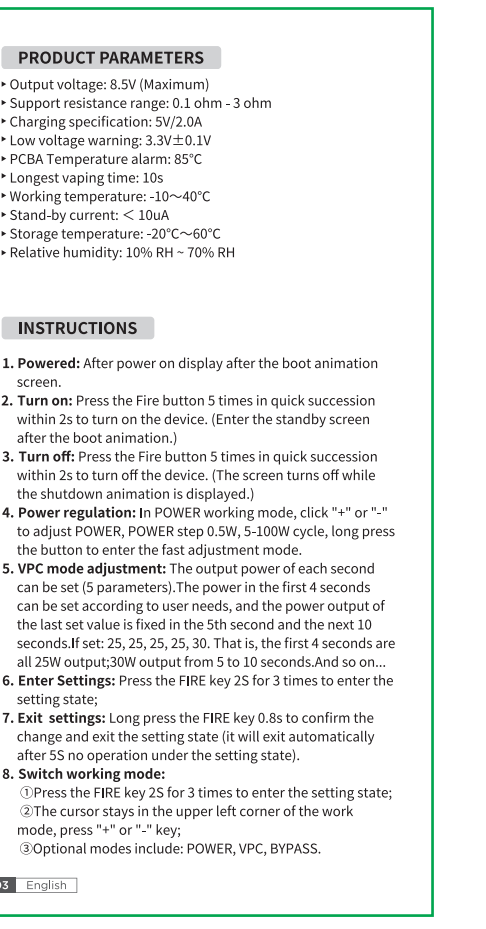

3

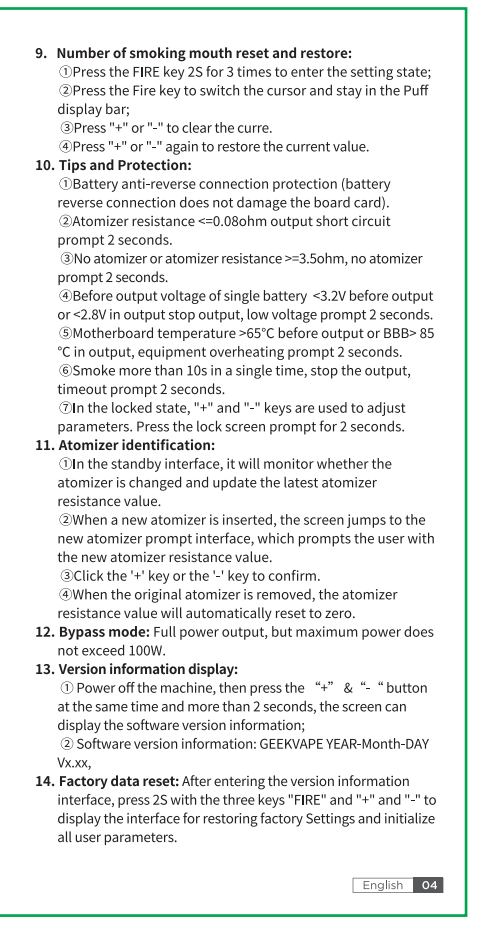

4

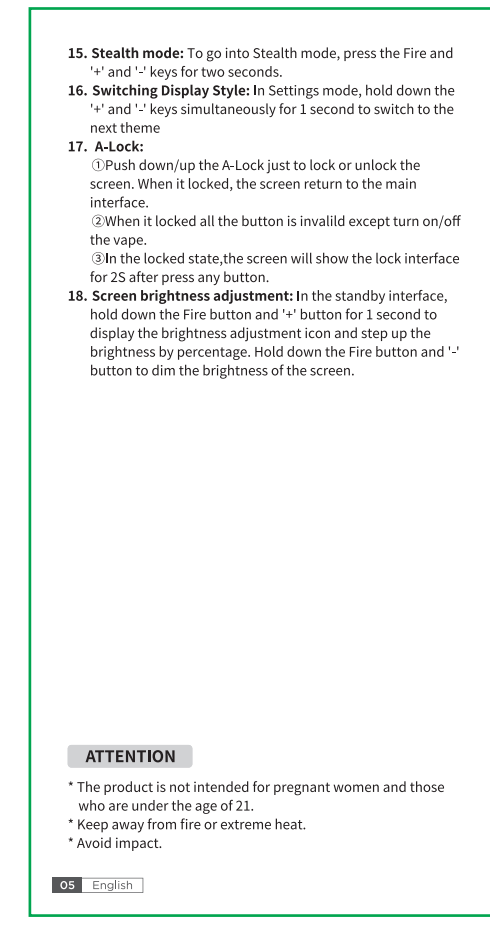

5

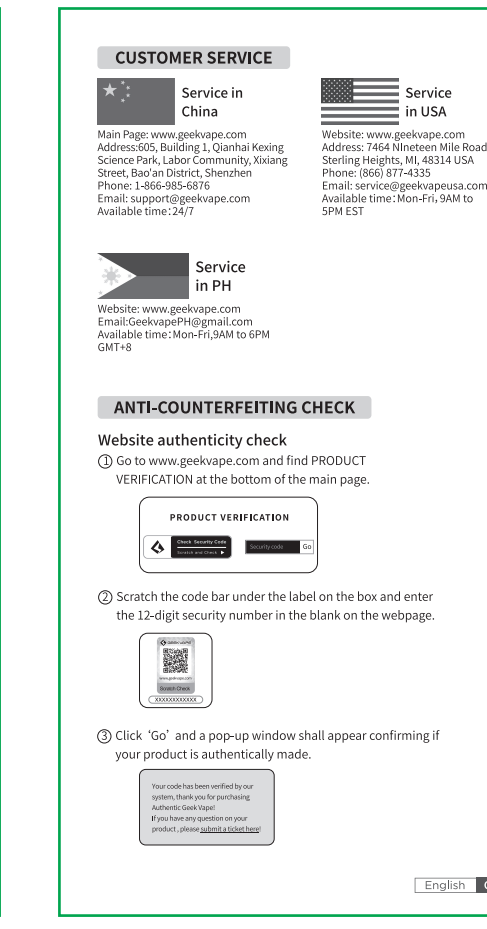

6

意大利语

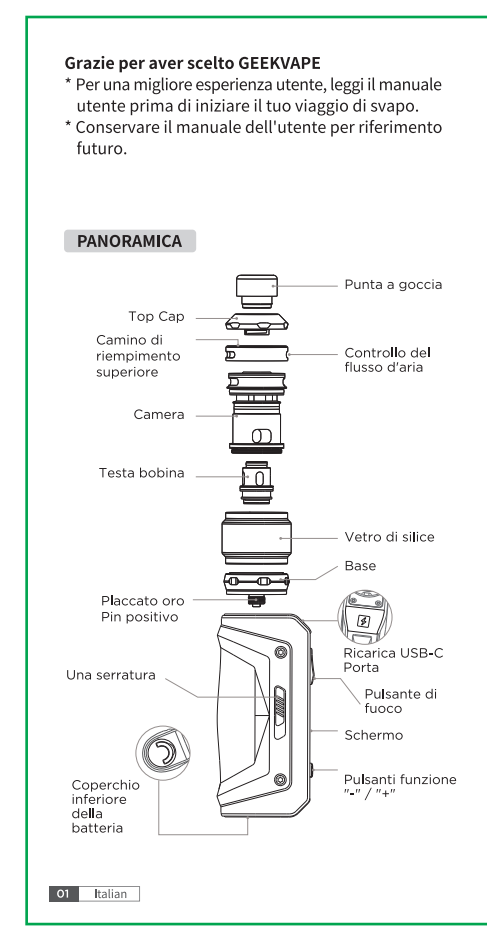

25

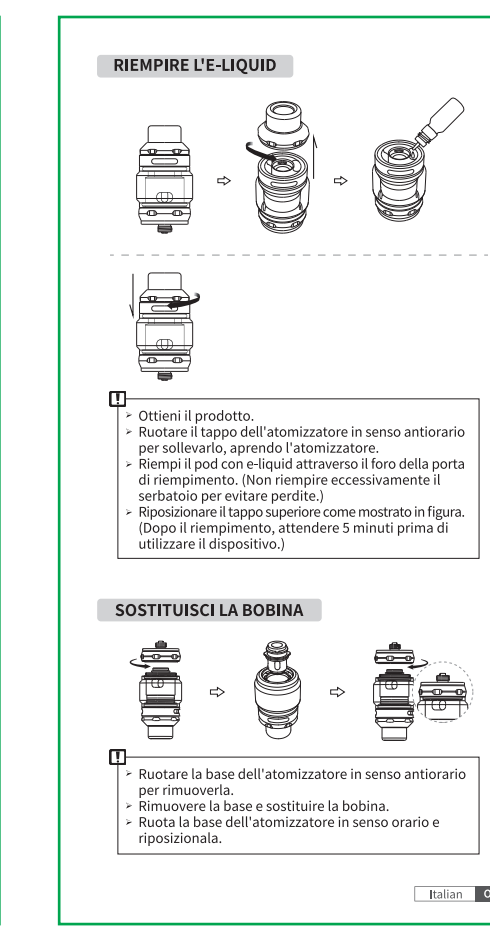

26

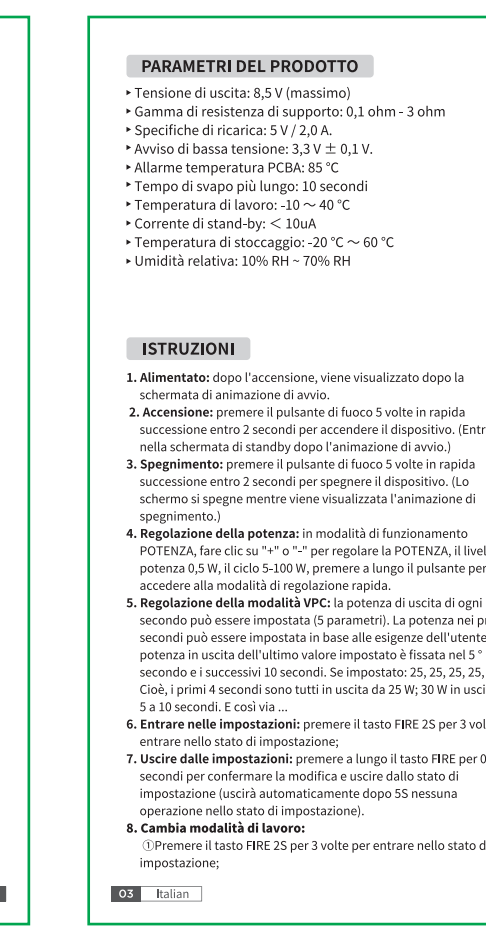

27

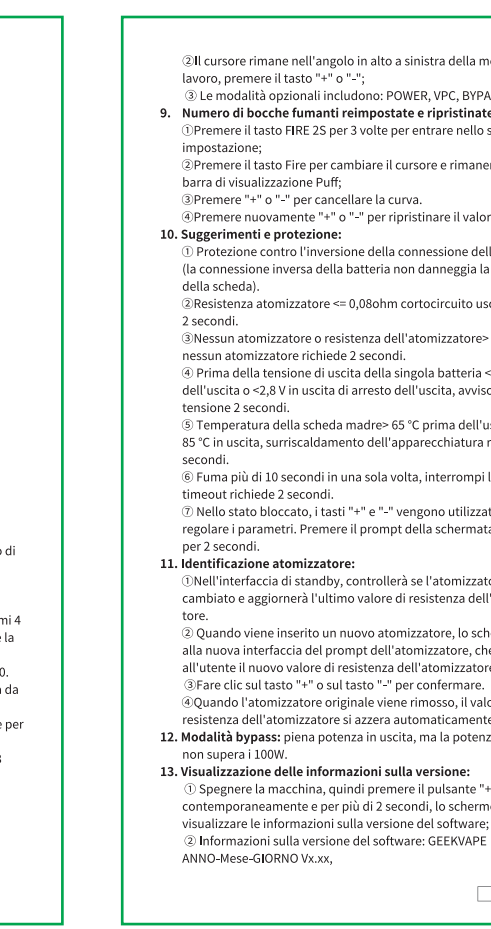

28

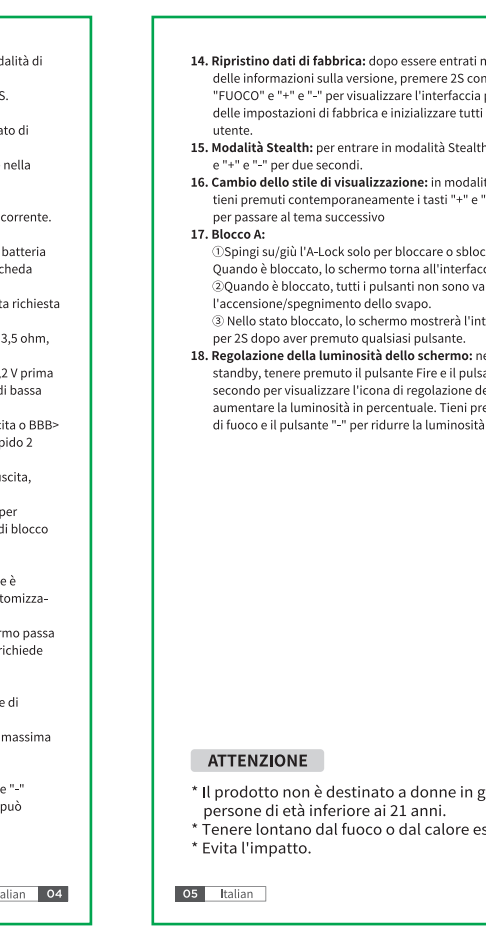

29

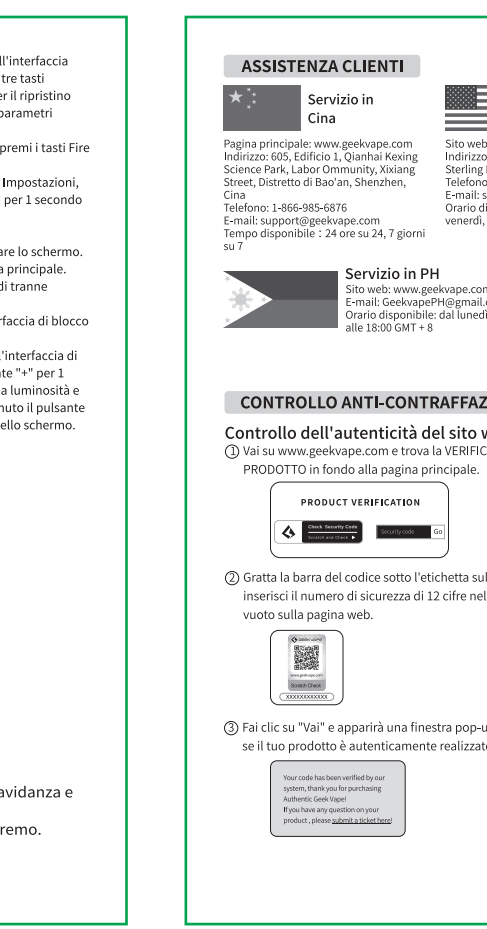

30

3

英语

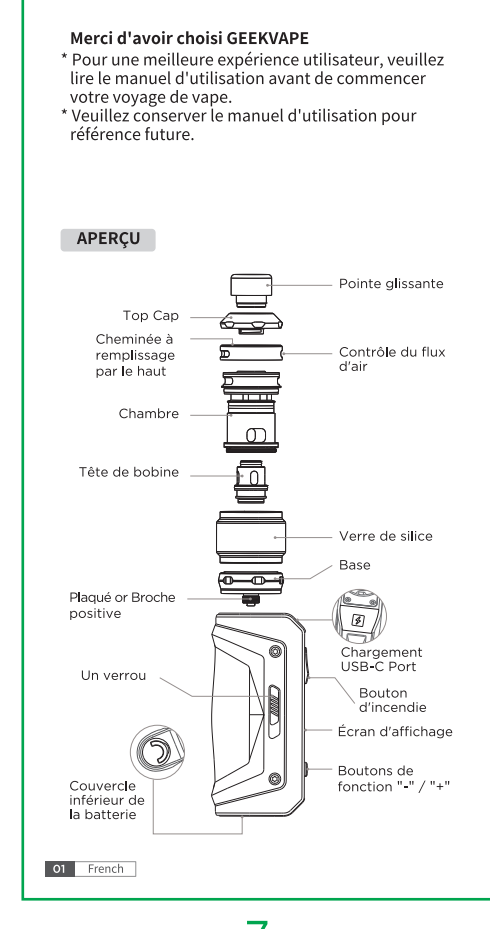

7

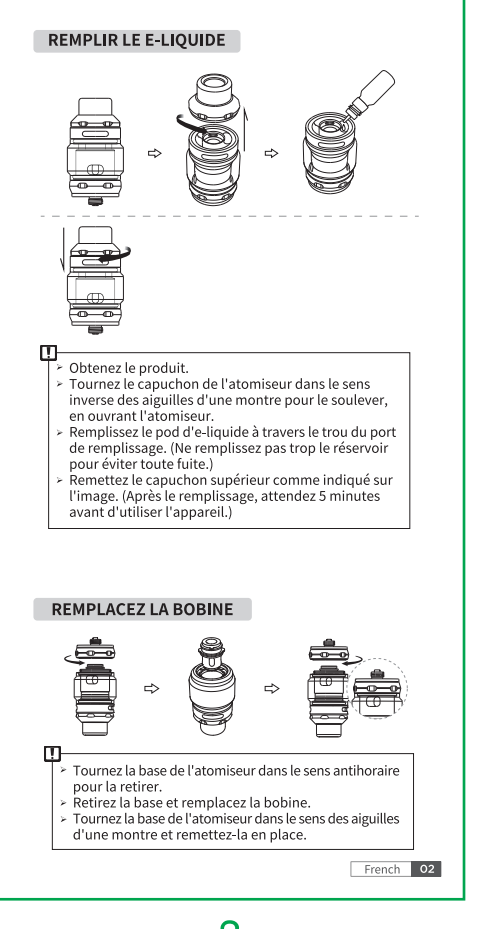

8

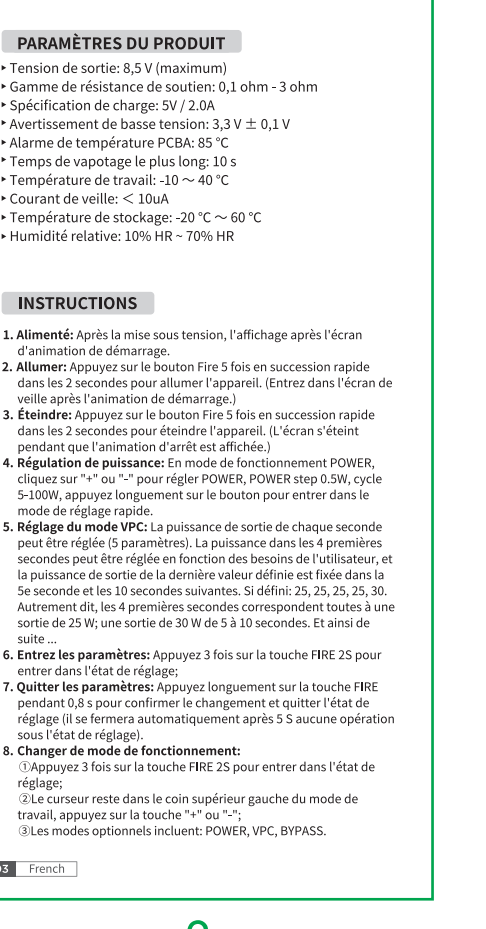

9

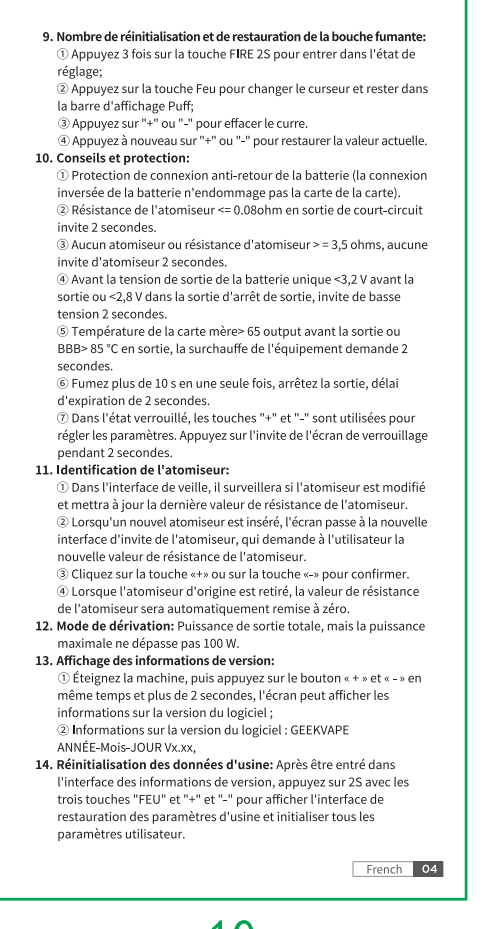

10

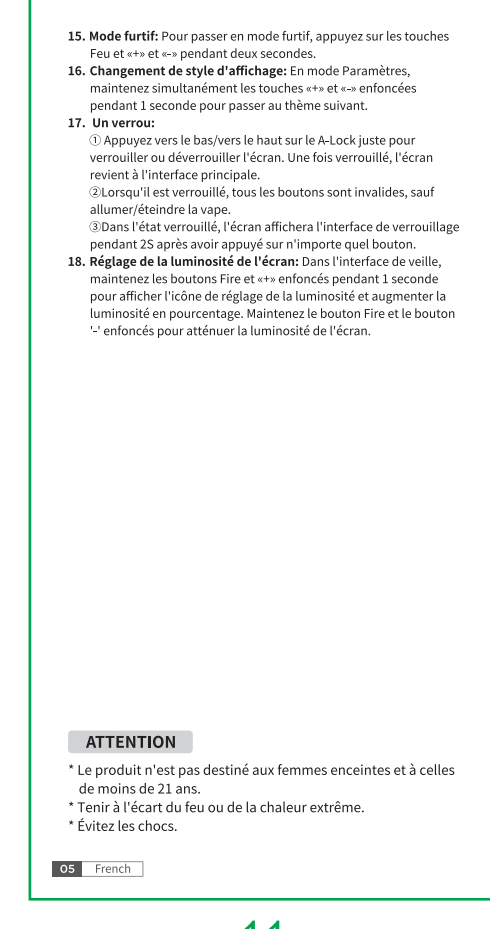

11

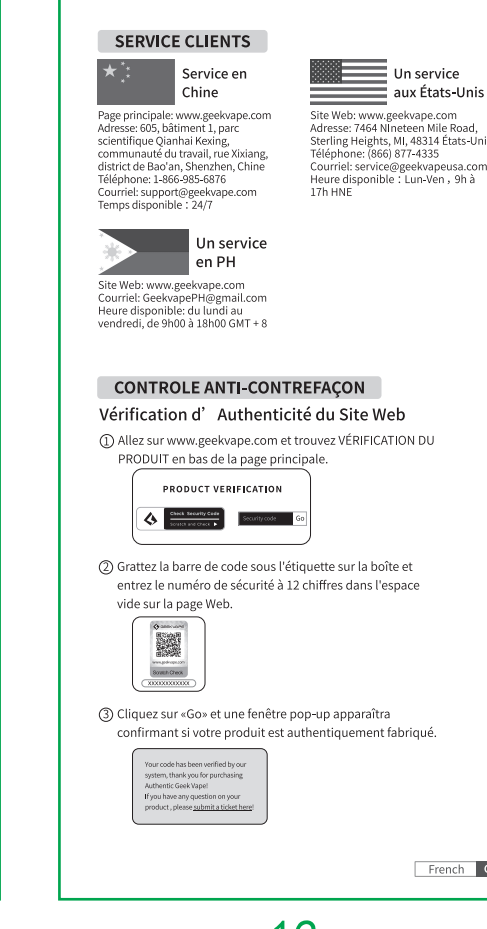

12

俄语

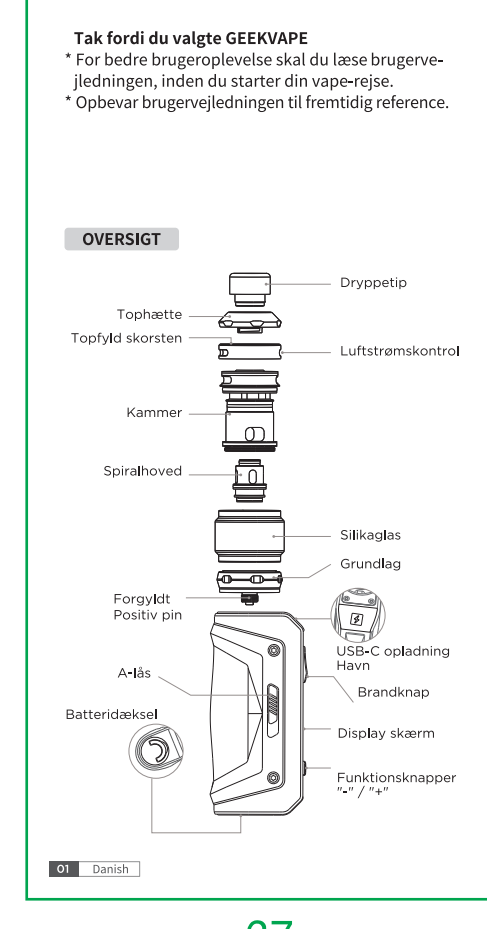

31

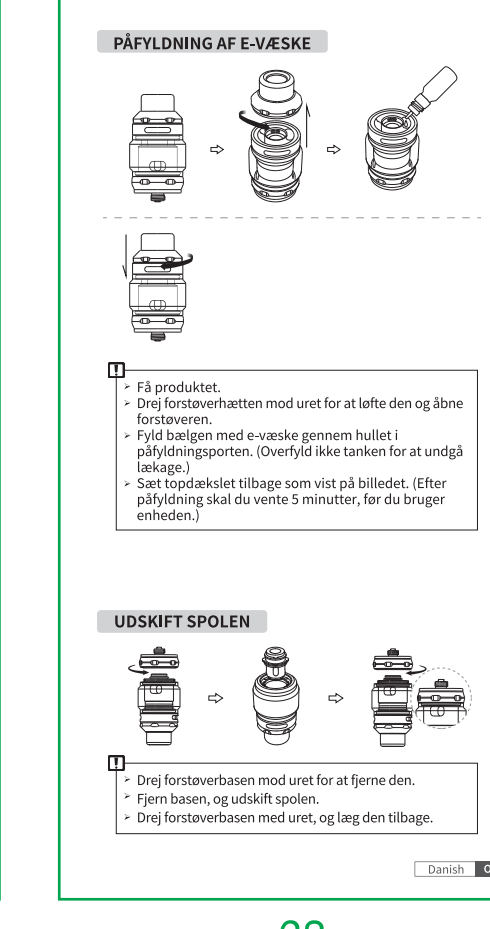

32

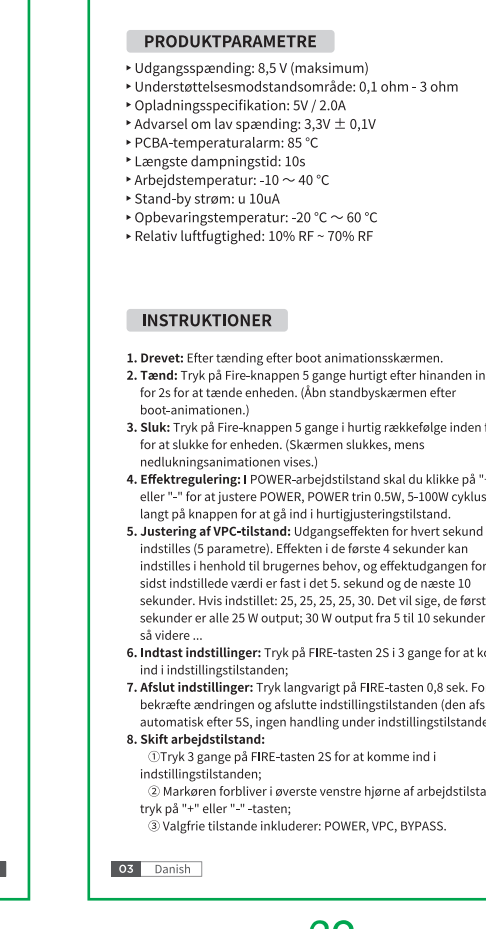

33

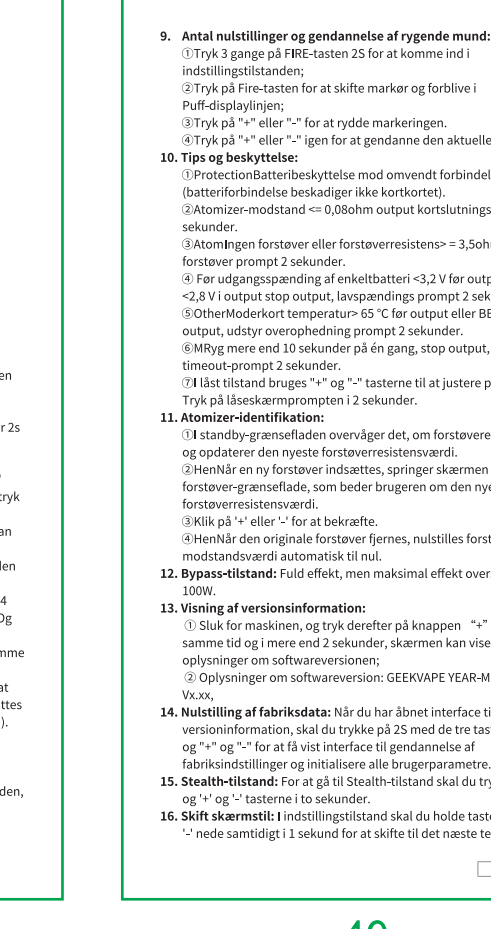

34



35



36

丹麦语

法语

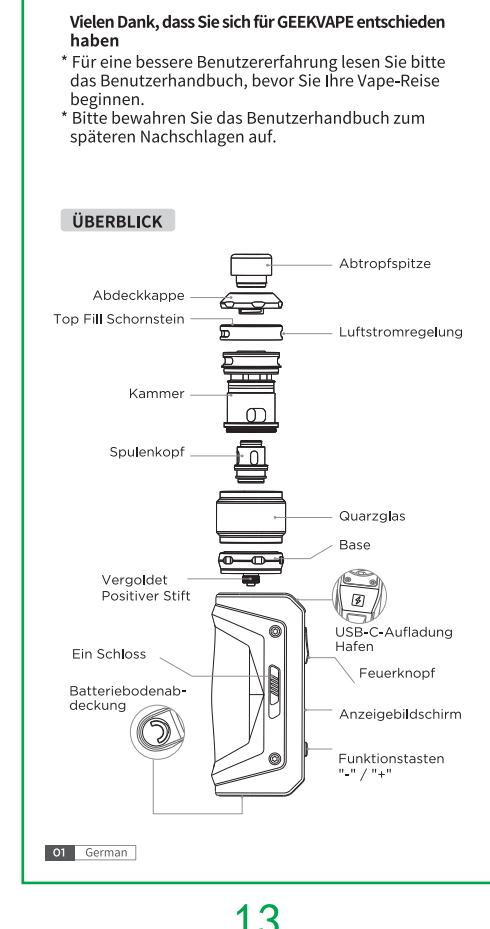

13

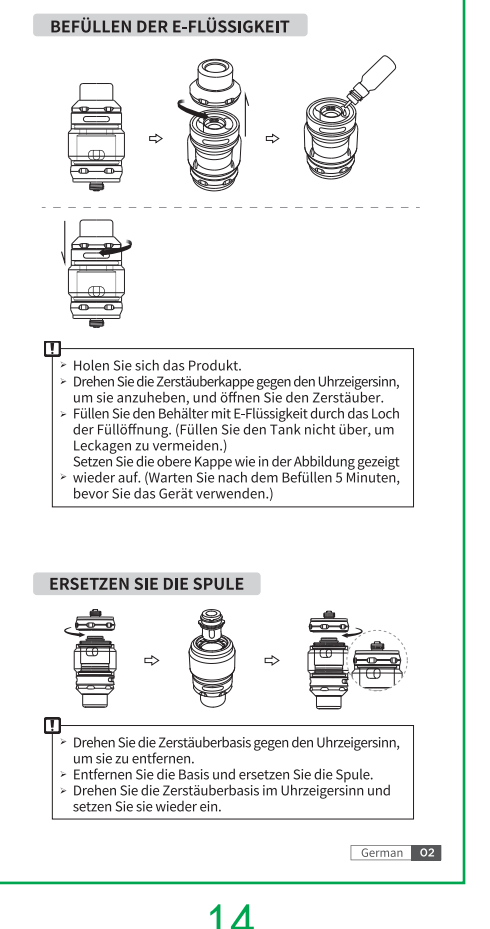

14

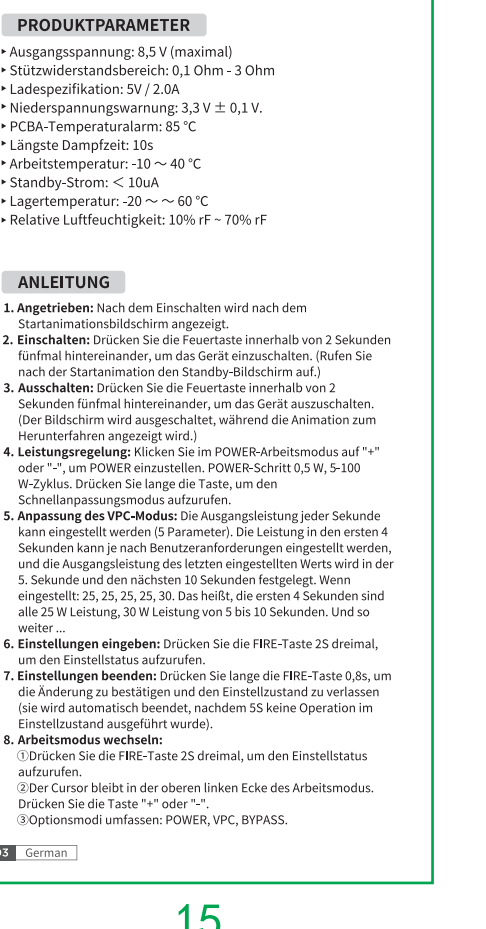

15

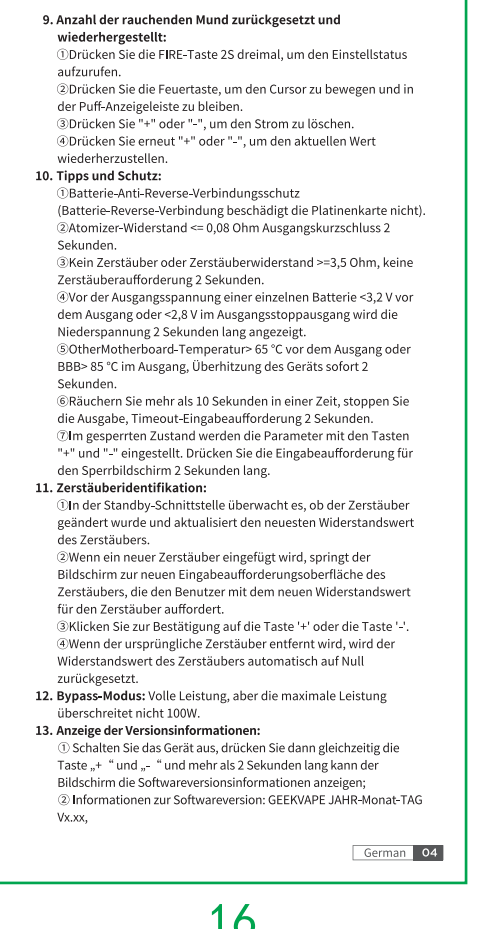

16

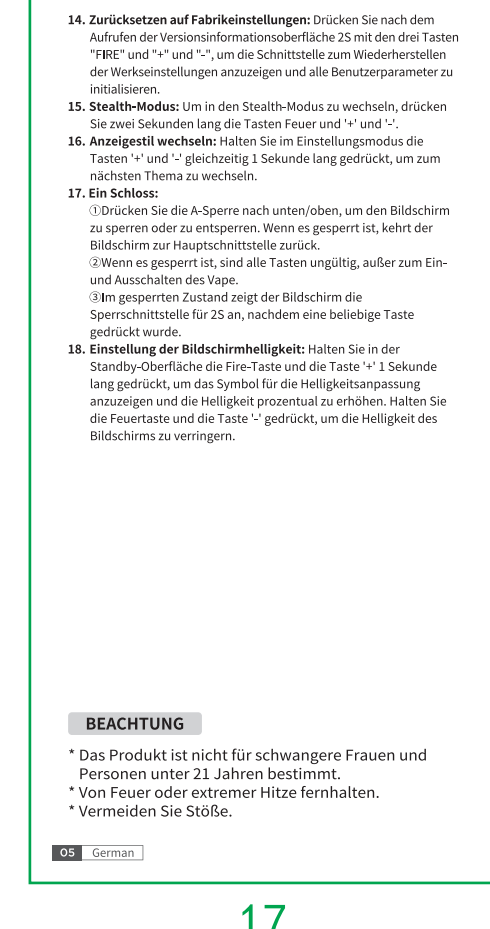

17

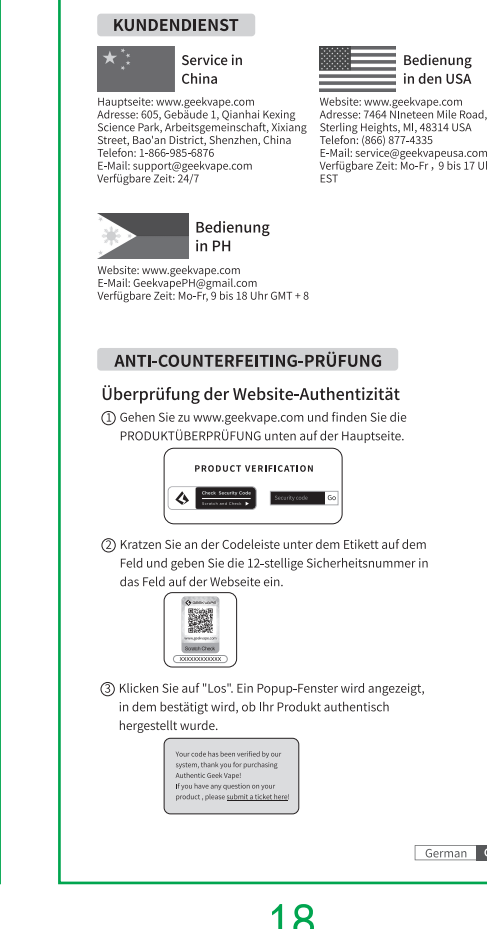

18

荷兰语

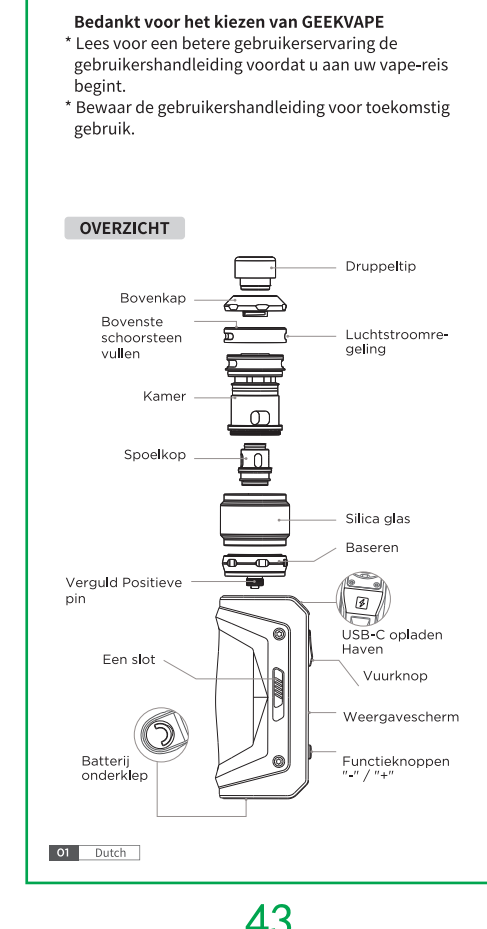

37

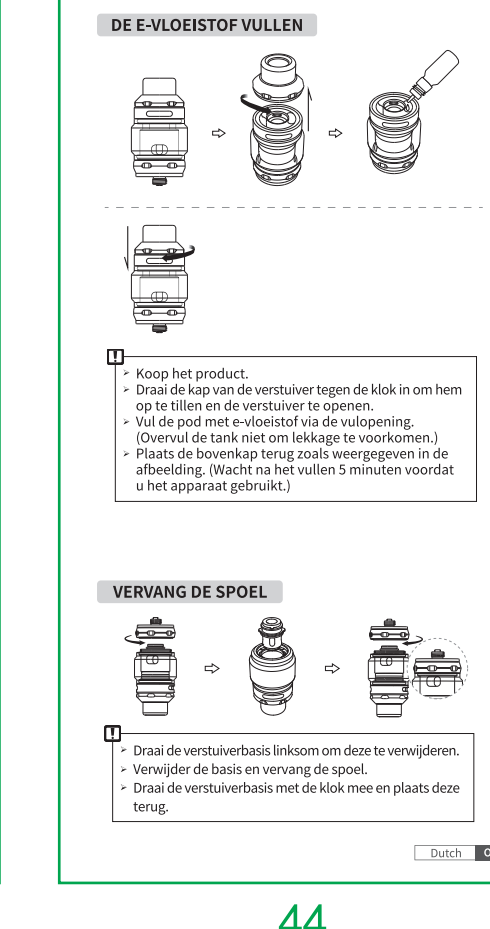

38

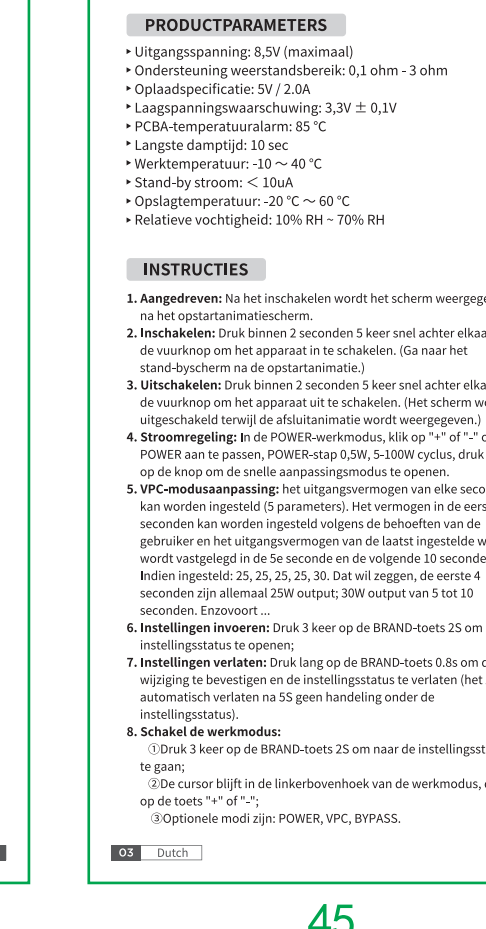

39

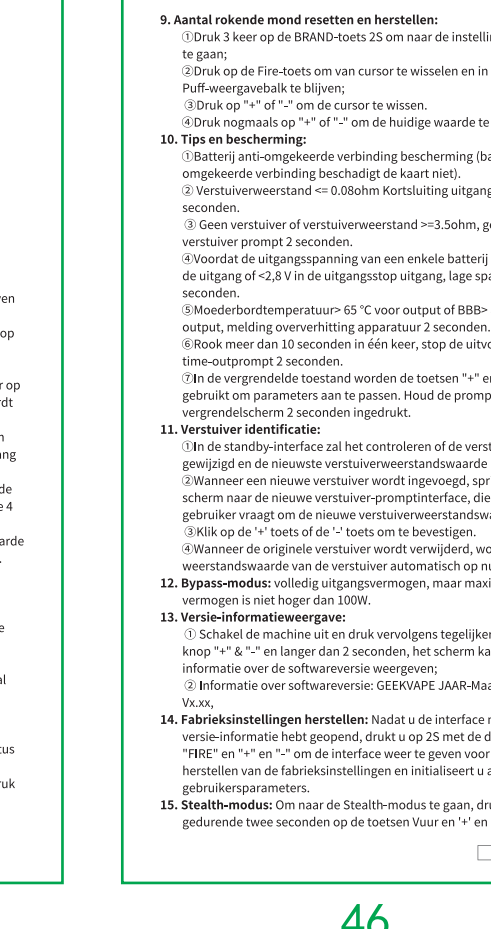

40

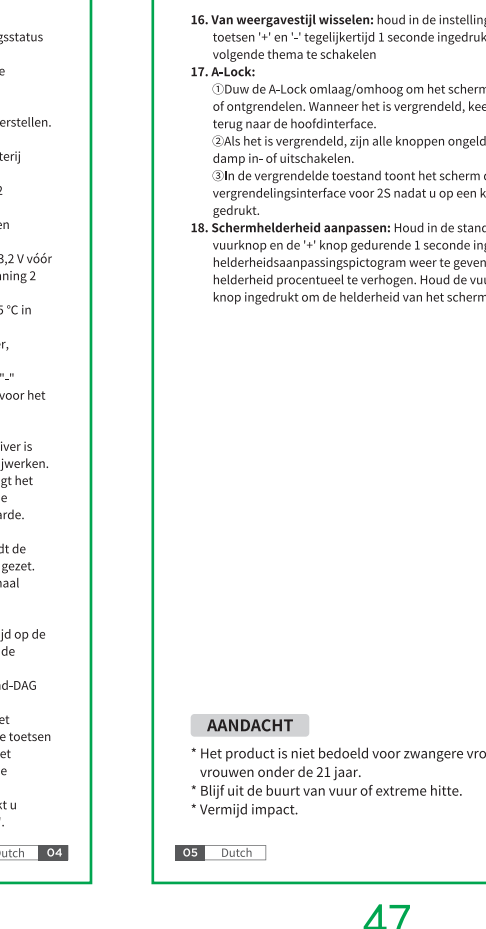

41

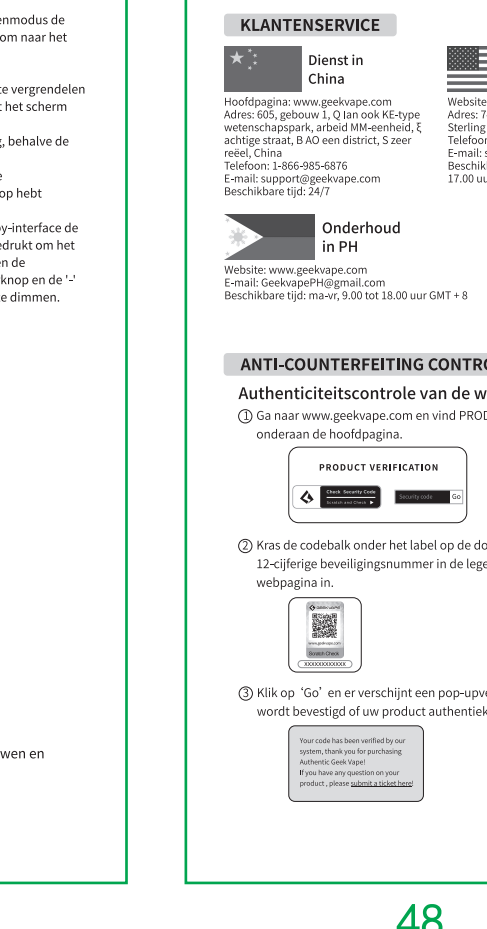

42

2

西班牙语

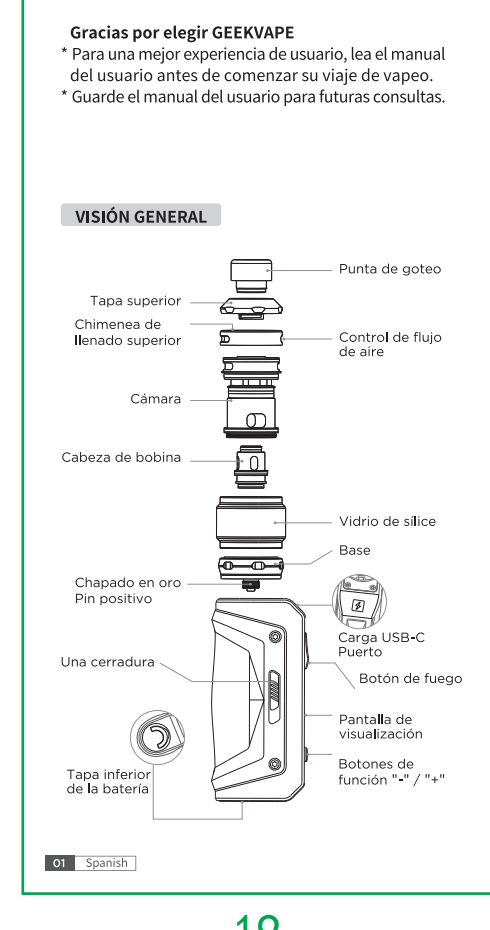

19

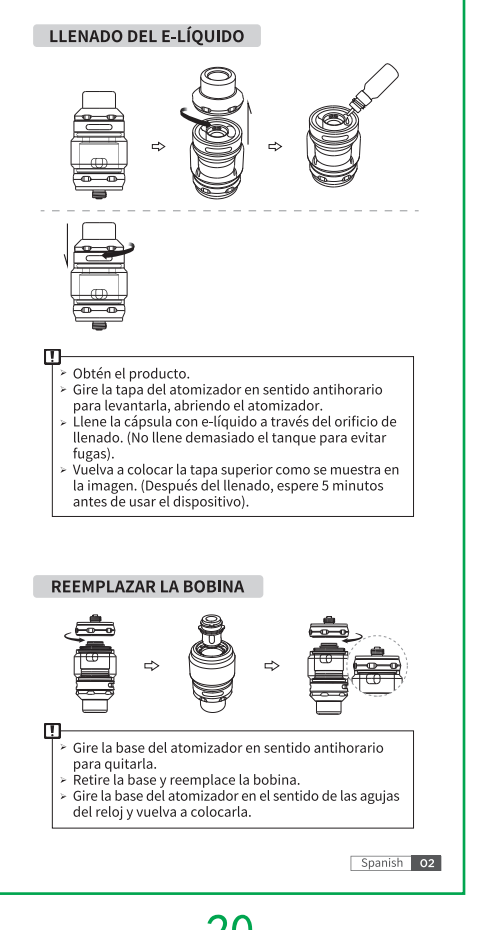

20

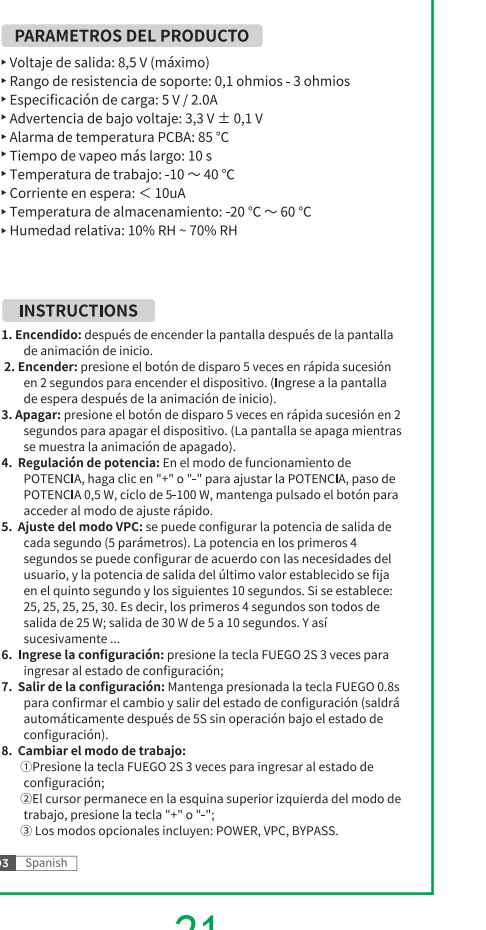

21

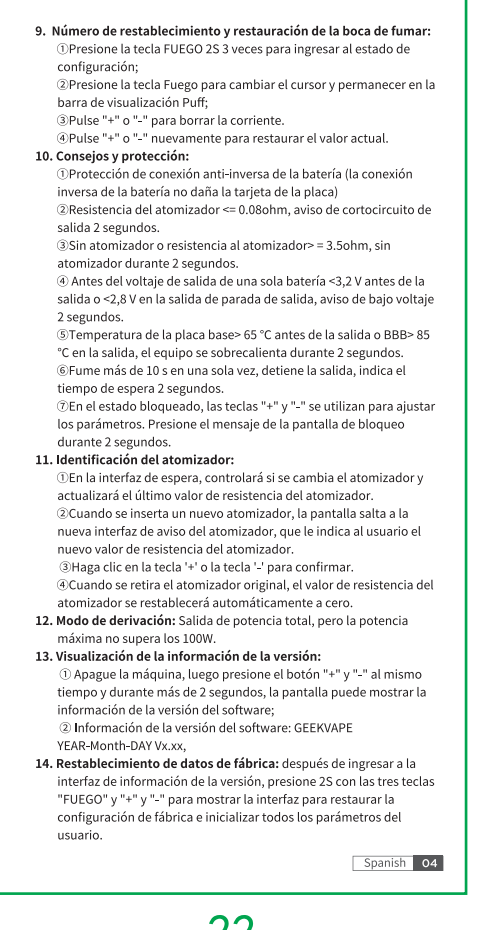

22

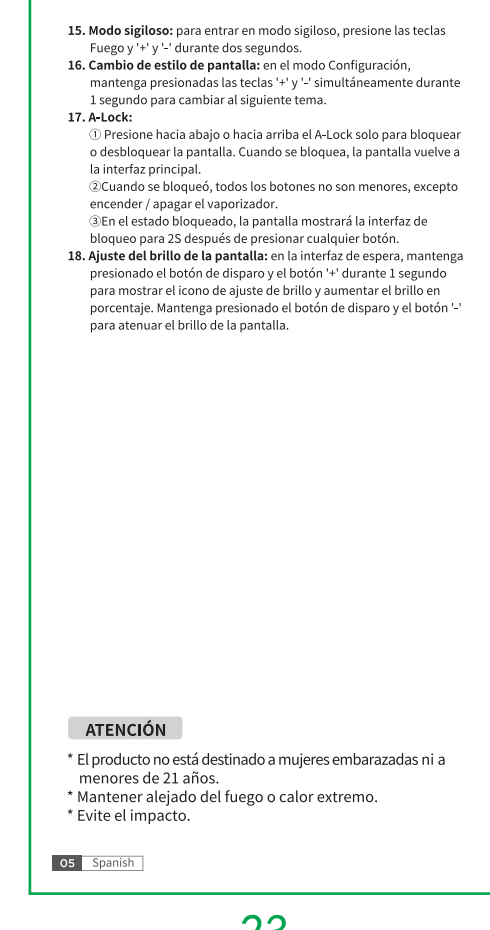

23

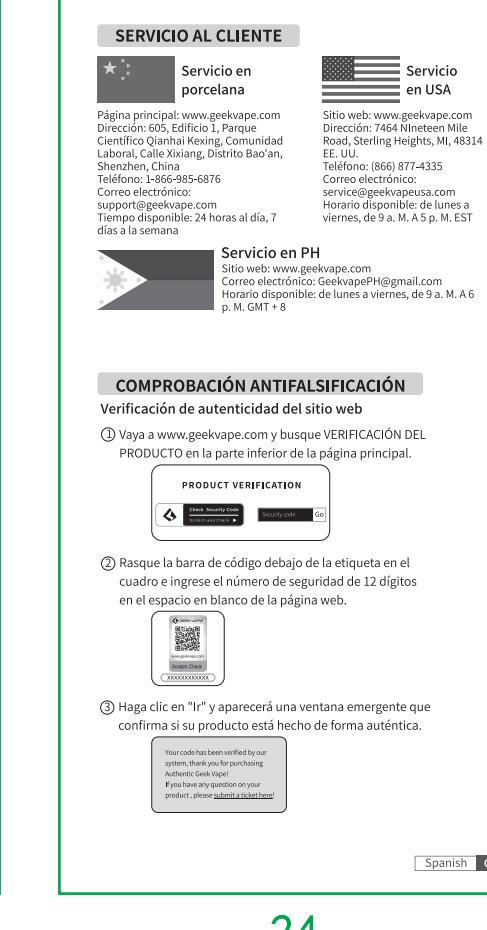

24

印尼语

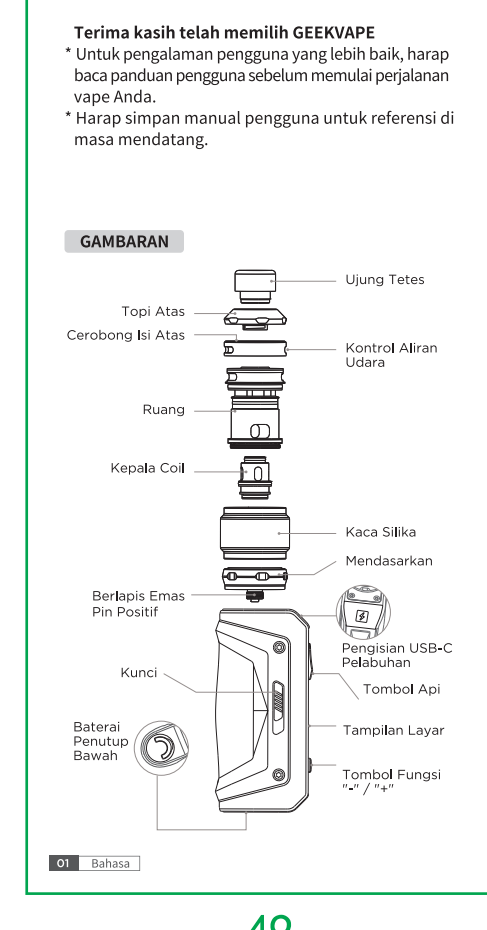

43

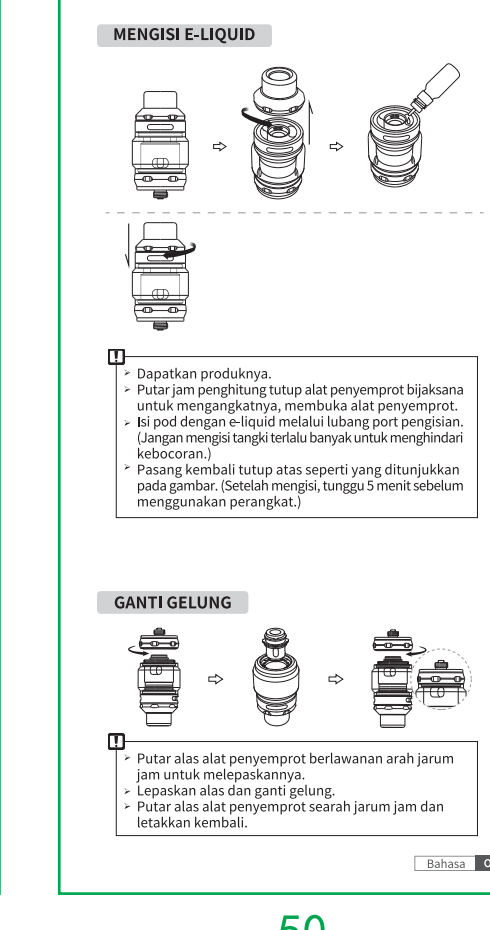

44

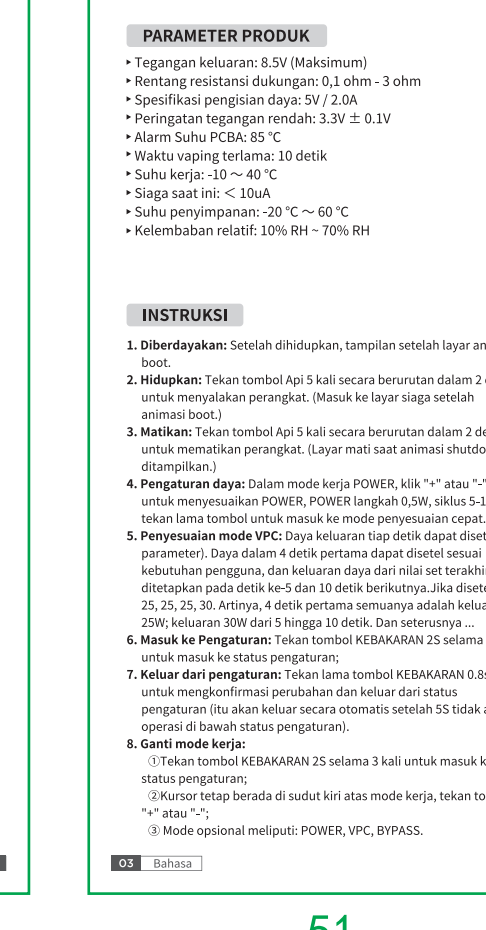

45

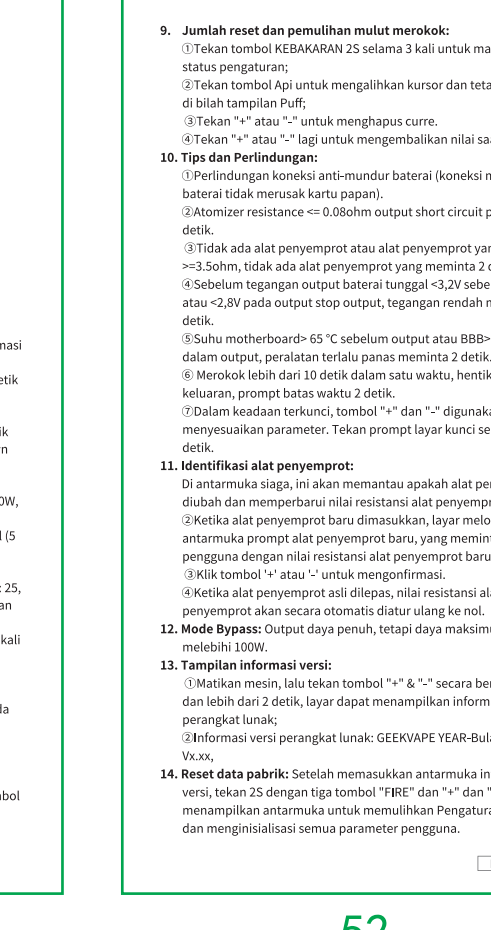

46

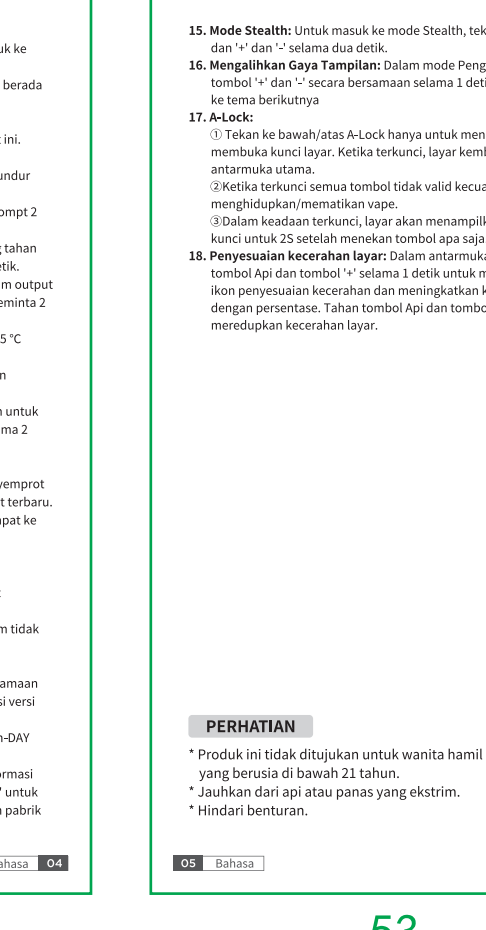

47

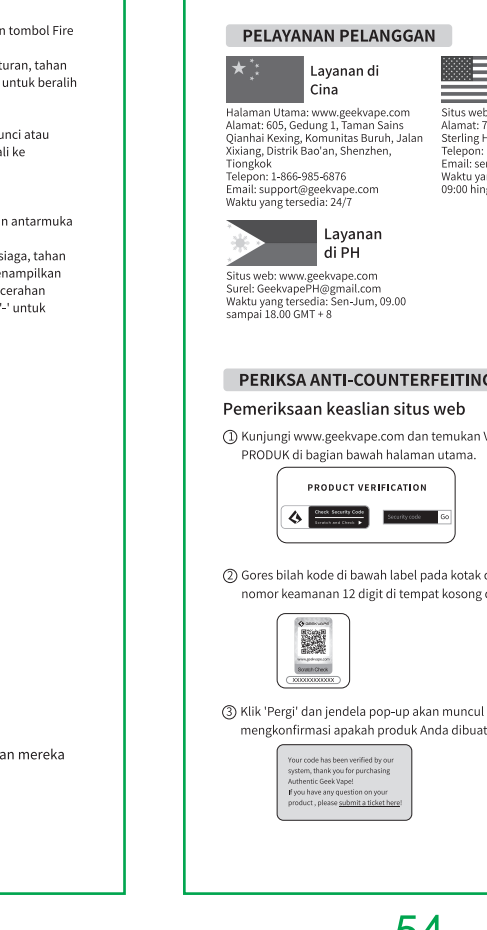

48



封底

- 要求:
1. 材料: 80g 书写纸
 2. 成品尺寸: 62*120mm ≤ 0.5
 3. 工艺: 双面印刷, 骑马订, 56P。
 4. 颜色: 印单黑, 色差 ΔE ≤ 1.00
 5. 油墨, 要符合欧盟为 RoHS 环保标准。
 6. 页码顺序依次按封面、1、2...53、54、封底
印刷以文件为准, 严格按图纸做货。裁切边缘须整齐无毛边。

 深圳市基克纳科技有限公司 Geekvape Technology co, LTD		绘图 PRODUCTNAME	魏鹏	比例 SCALE
		审核 CHECKED	2024/6/5	1:1
未标公差 OTHER TOLERANEC	产品名称 PRODUCTNAME	Aegis Solo 2 kit - 说明书	核准 APPROVED	UNIT(单位): mm
	产品编码 PART NO	GS0026		REV(版本): A2
	产品图号 PART NO	GS0026-P-11		