

A

B

C

D

E

F

4



封底

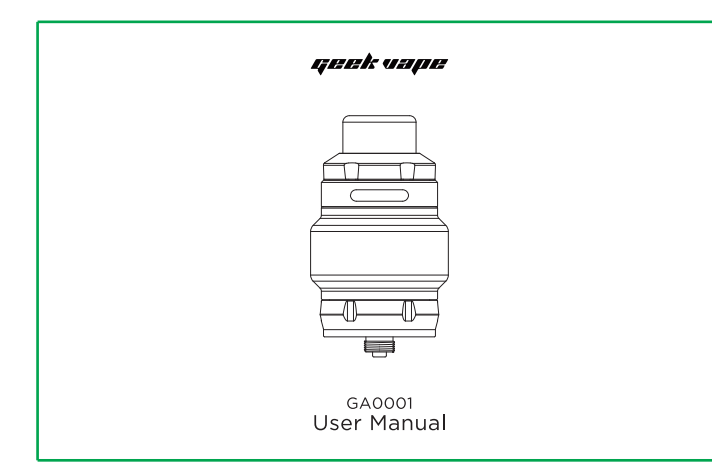

封面

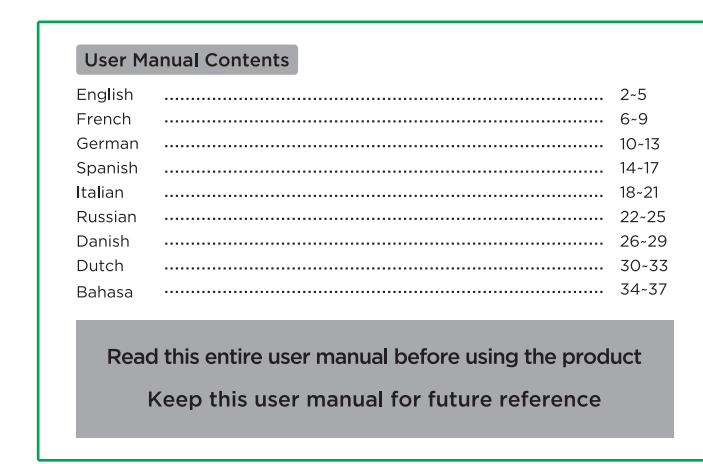

01

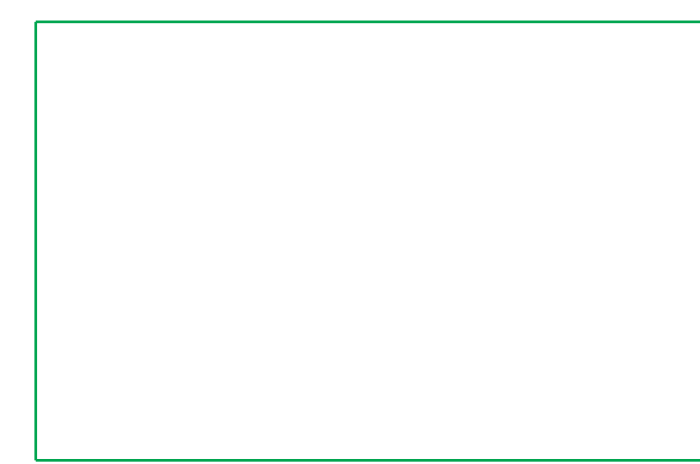

封二

3

英语

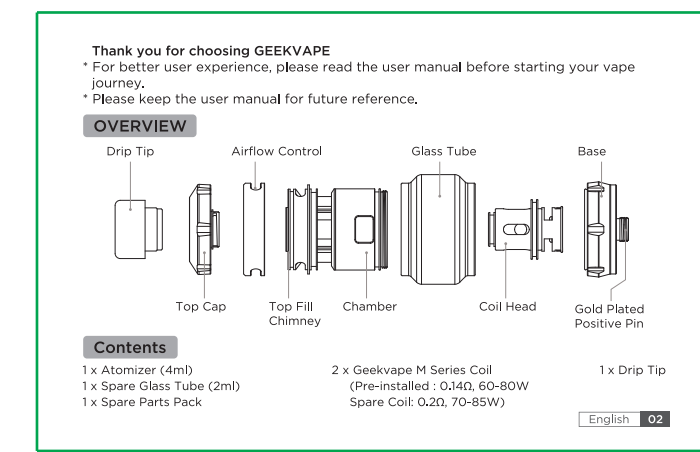

02

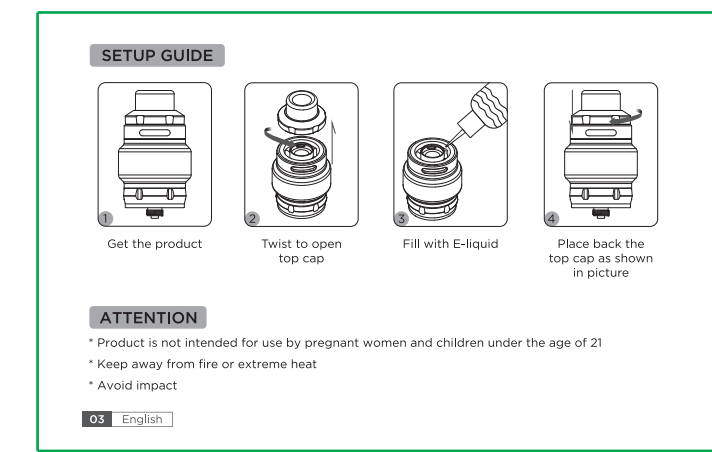

03

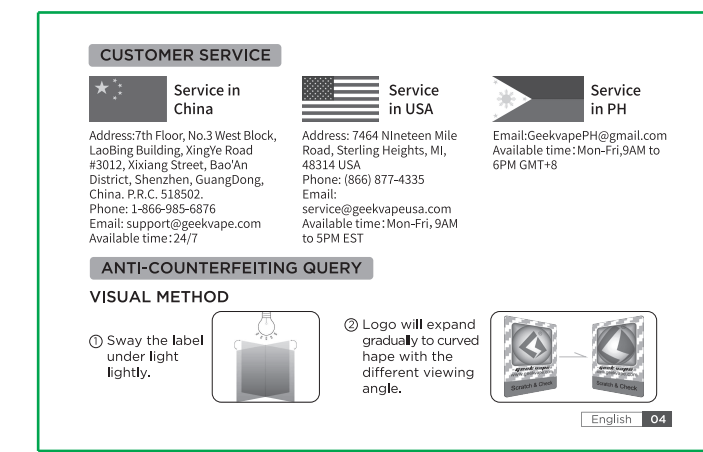

04

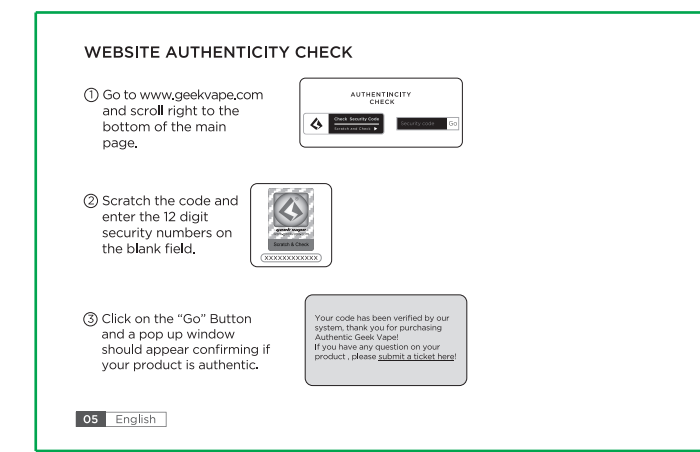

05

法语

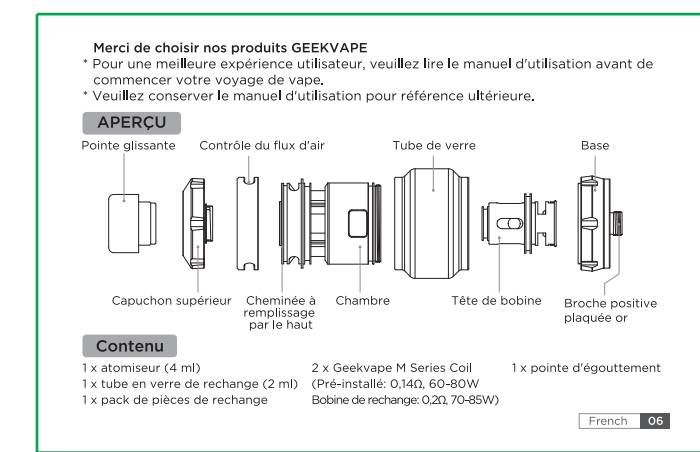

06

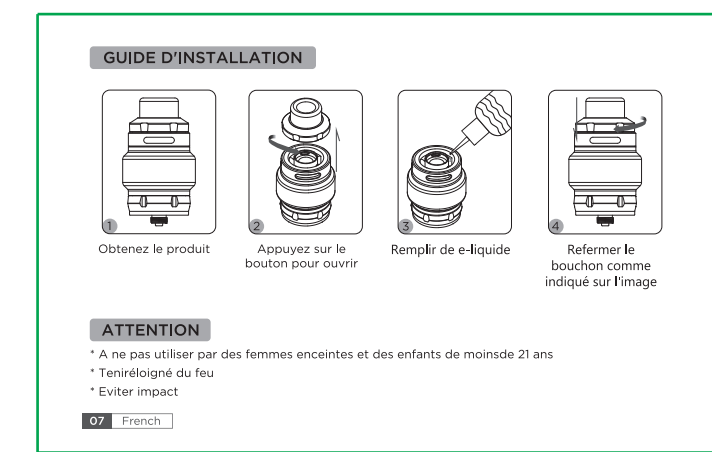

07

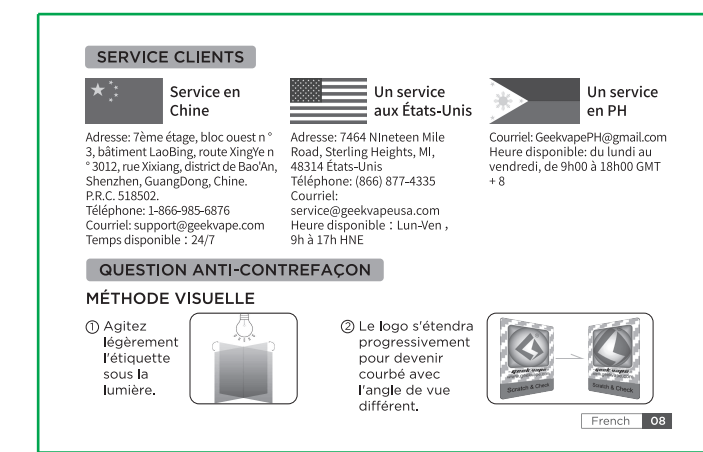

08

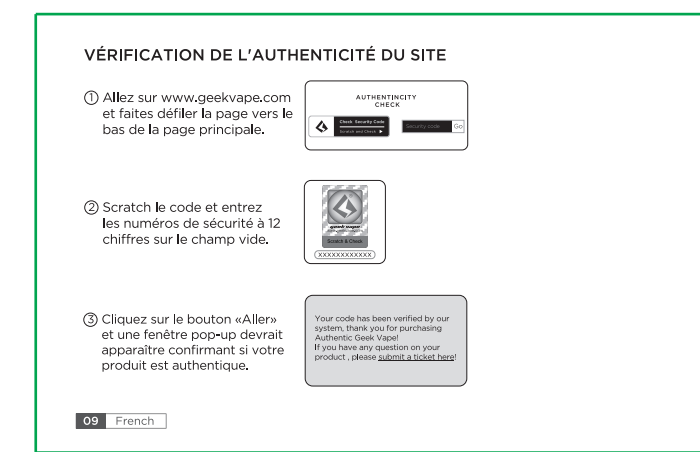

09

德语

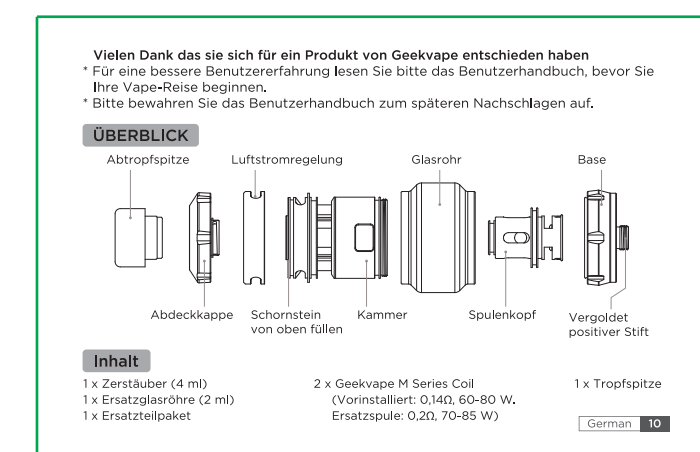

10

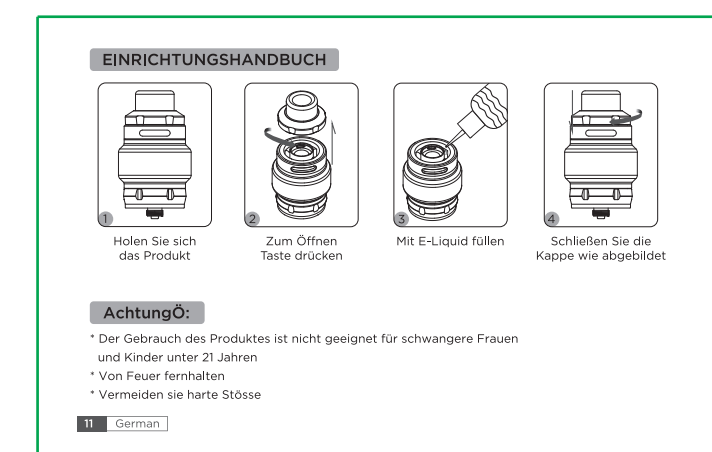

11

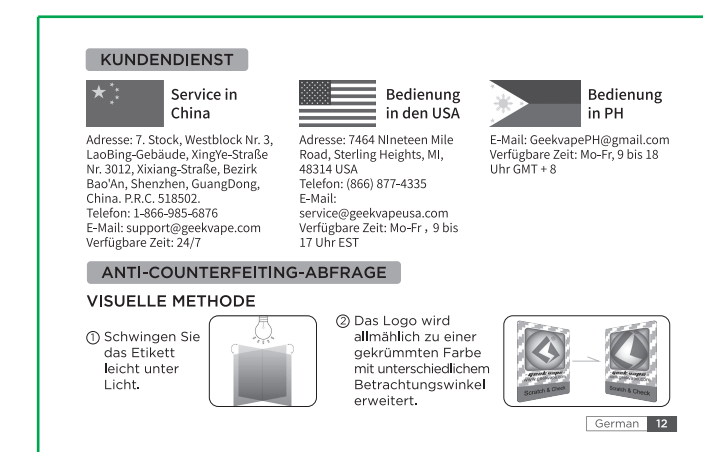

12

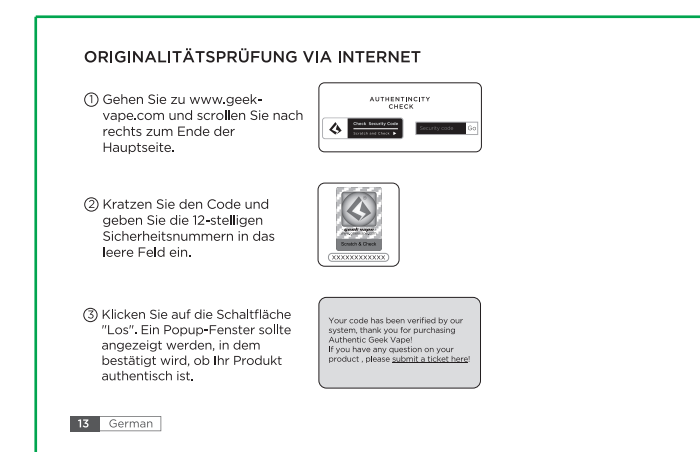

13

2

西班牙语

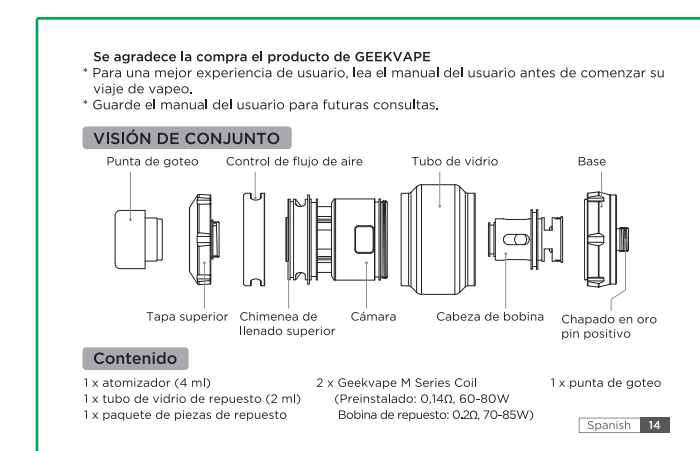

14



15

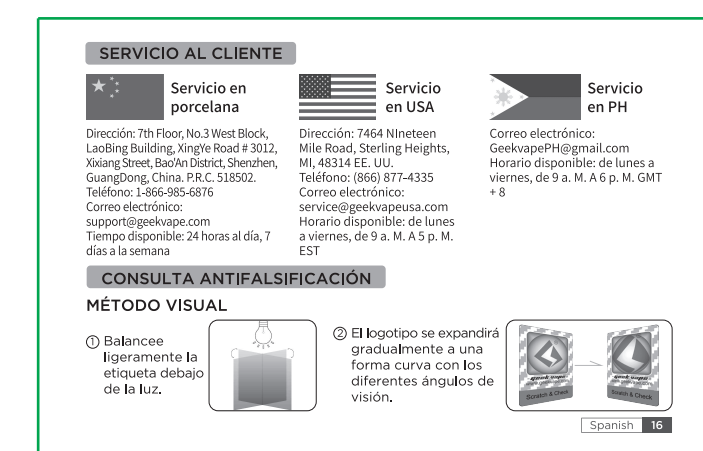

16

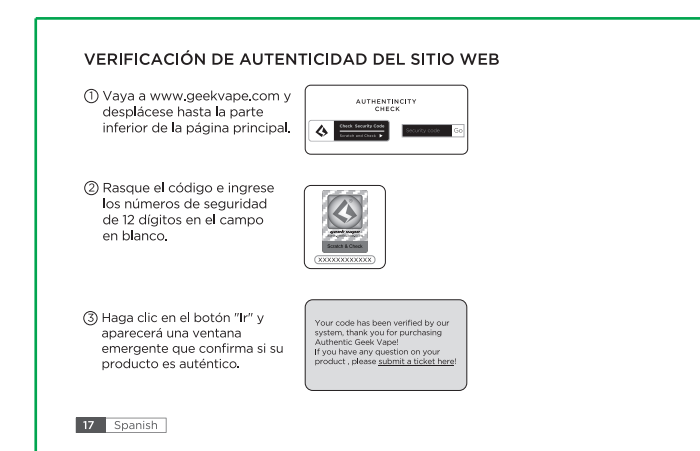

17

意大利

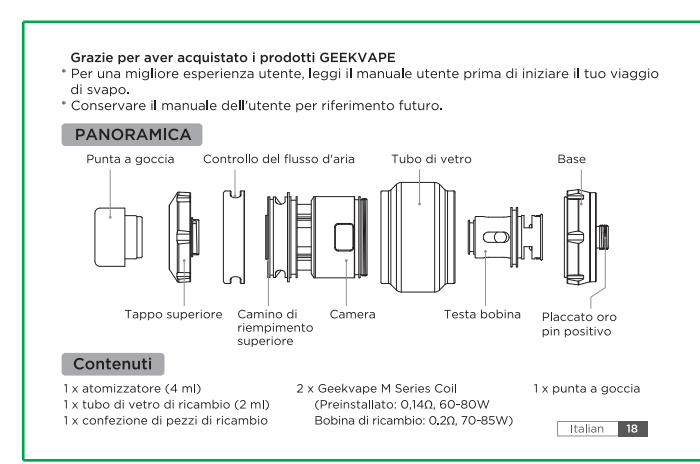

18

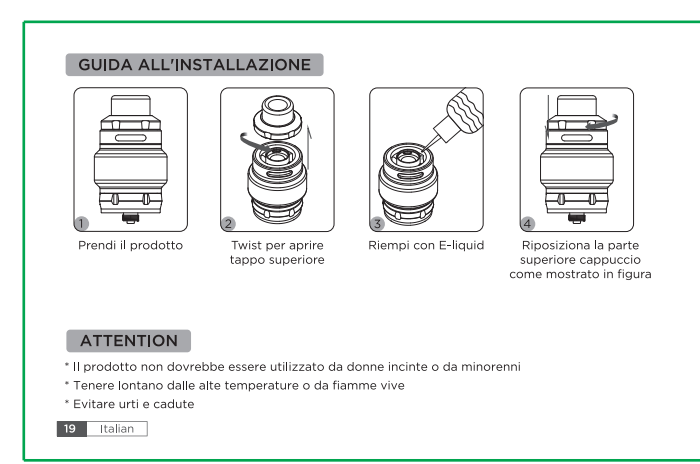

19

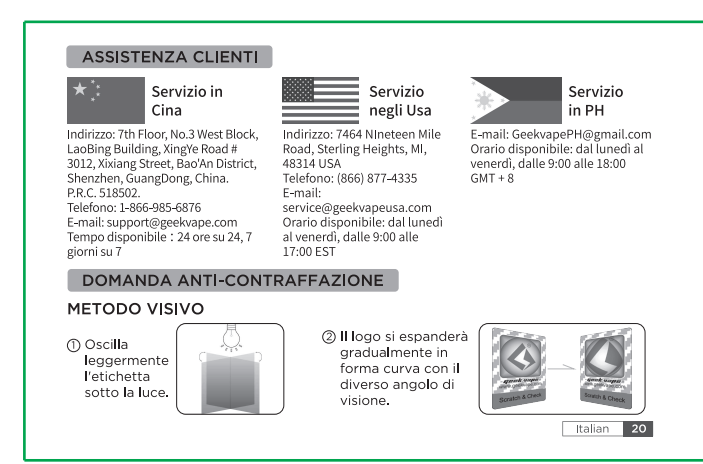

20



21

俄语

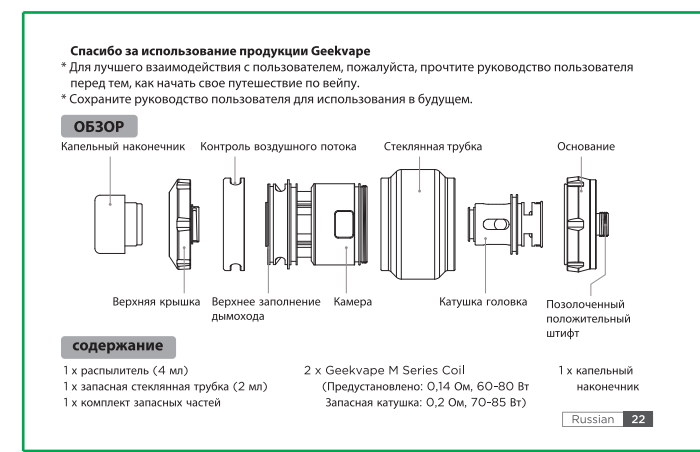

22

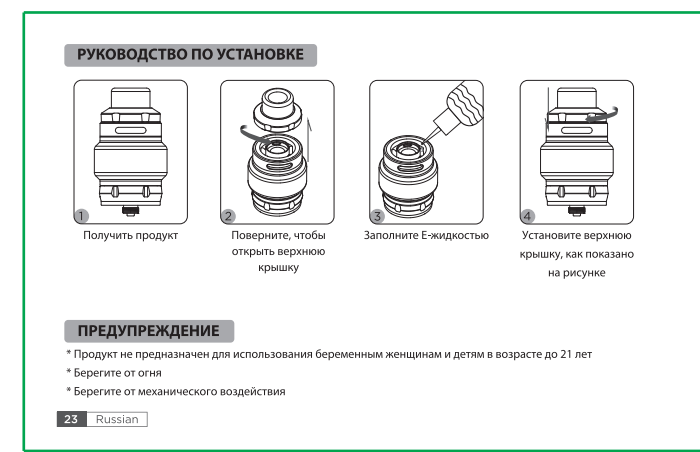

23

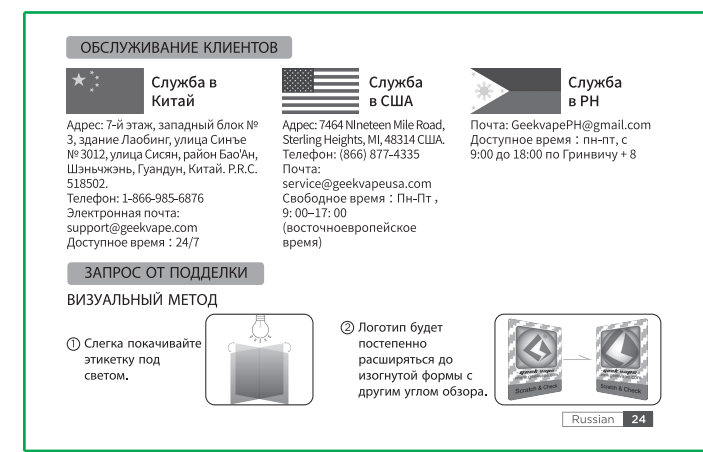

24

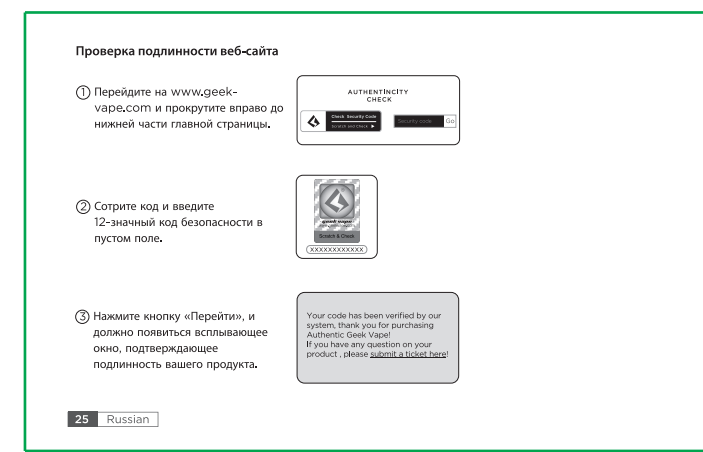

25

丹麦

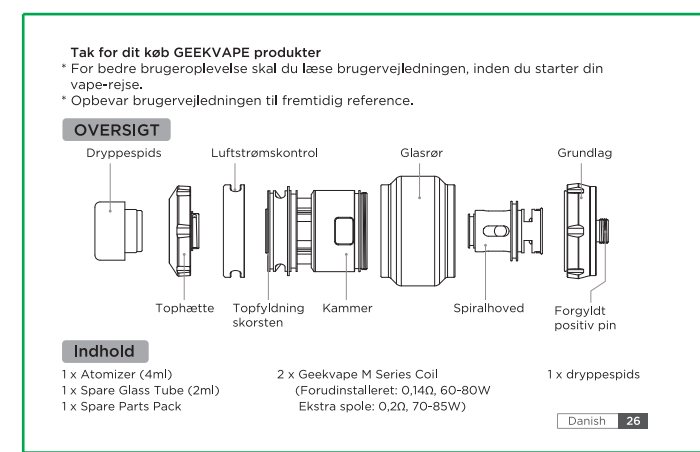

26

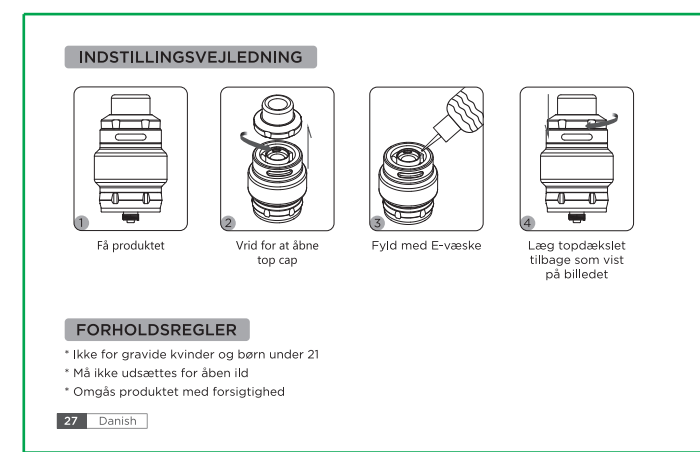

27

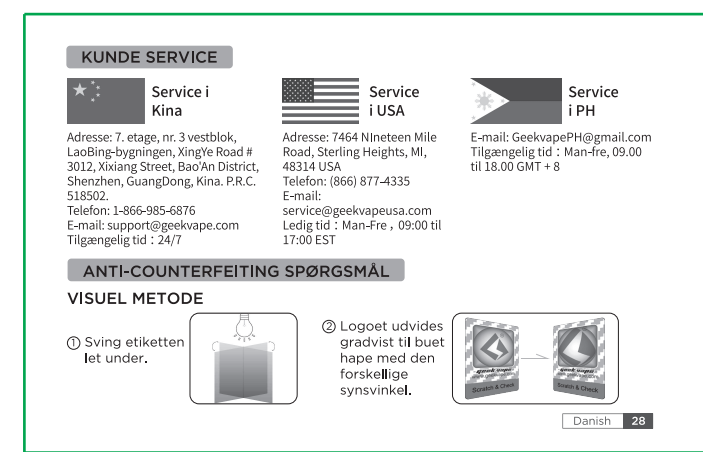

28

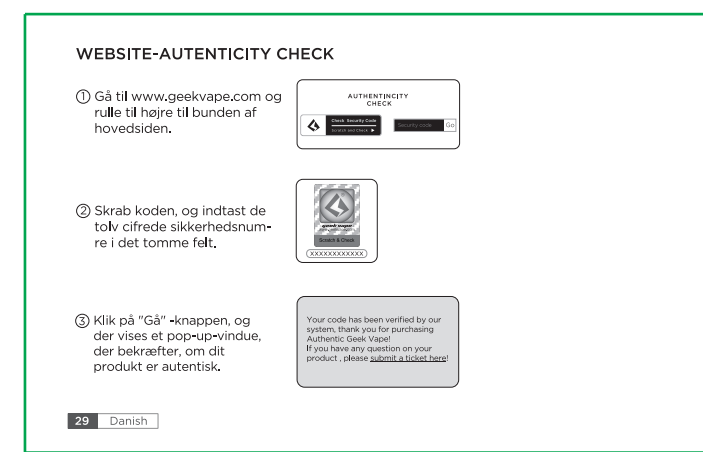

29

荷兰

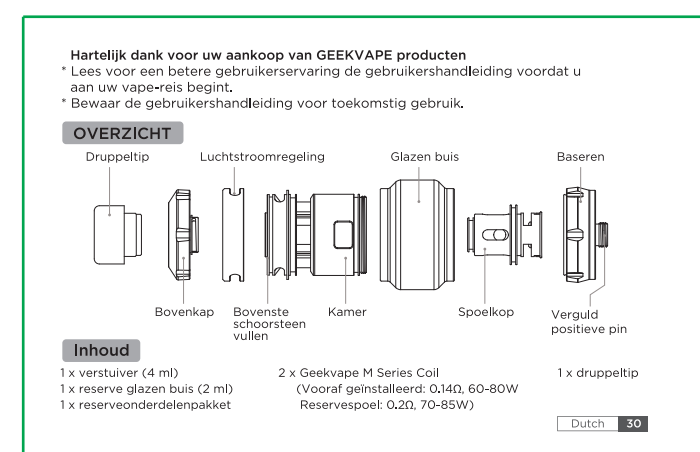

30

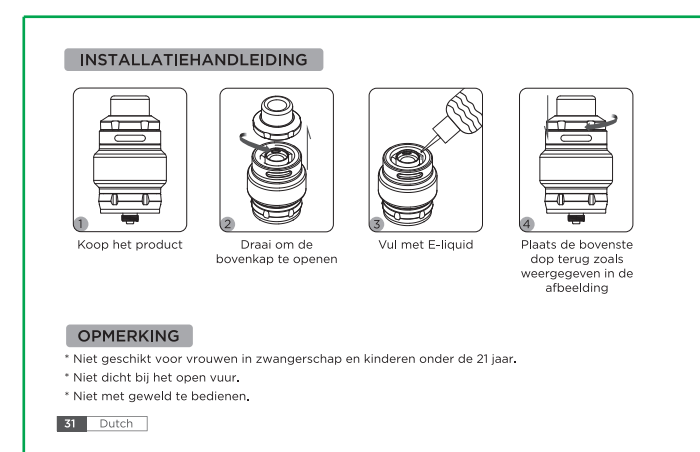

31

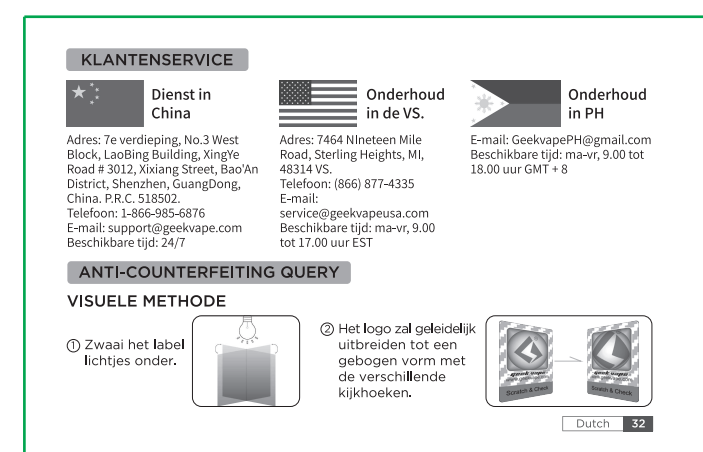

32

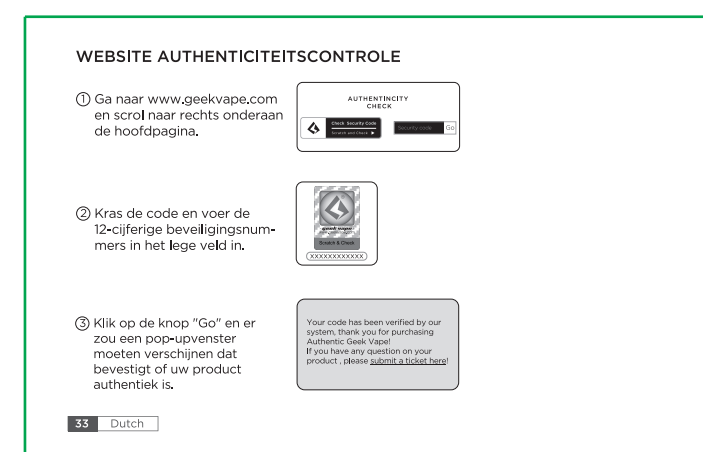

33

印尼

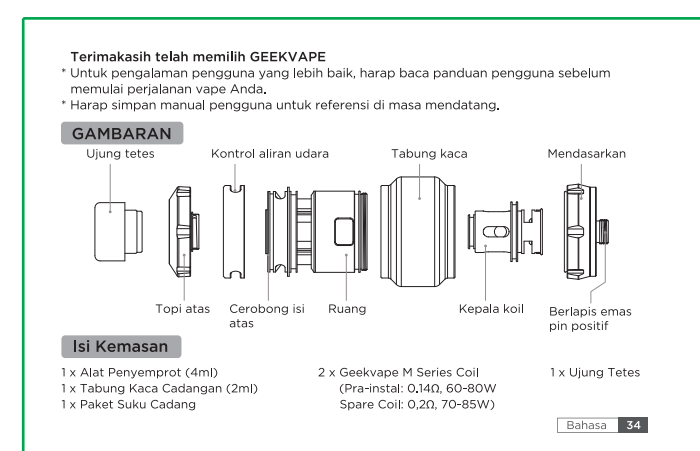

34

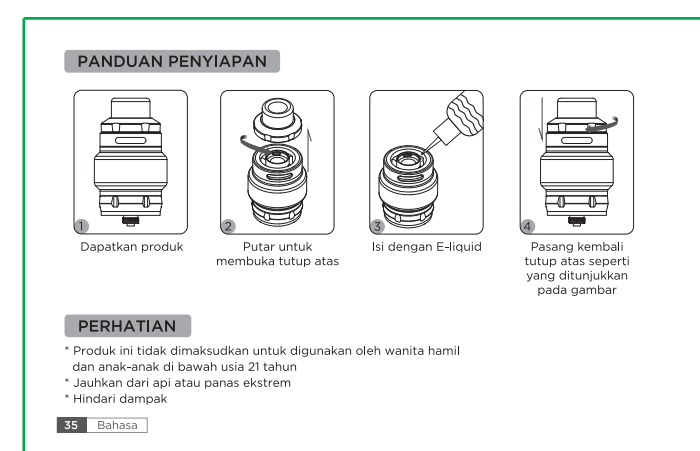

35

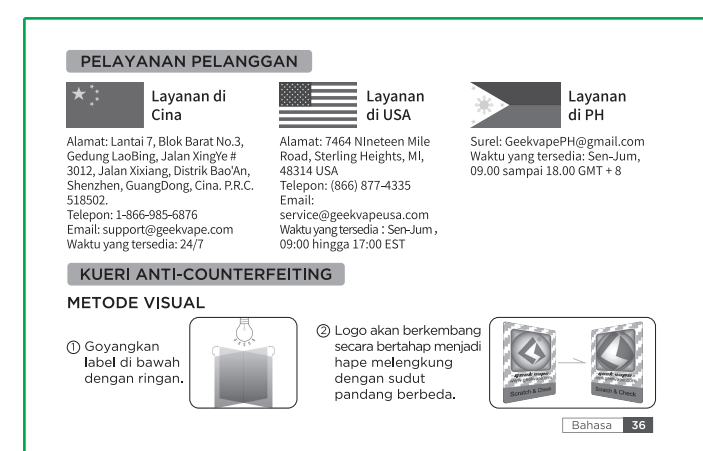

36

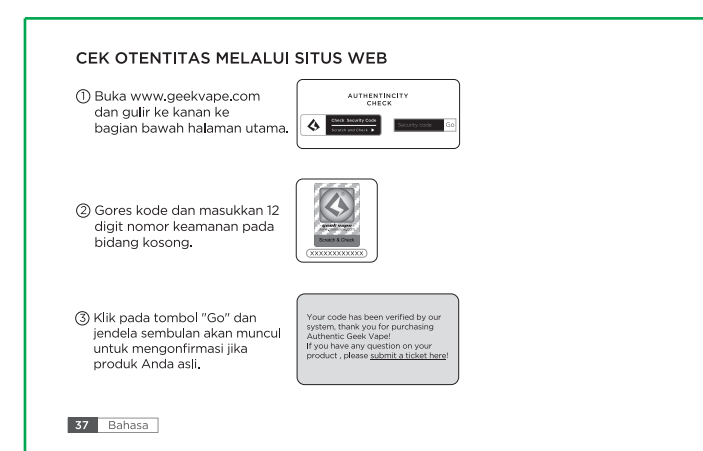

37

(注：与A0版相比更改了配送芯子信息)

- 要求：
1. 材料：80g书纸
  2. 成品尺寸：90\*58mm ≤ 0.5
  3. 工艺：双面印刷，骑马订装订。
  4. 颜色：K，色差ΔE ≤ 1.00；
  5. 油墨，要符合欧盟为RoHS环保标准。
  6. 页码顺序依次按封面、封一、2...37、封二、封底  
印刷以文件为准，严格按图纸做货。裁切边缘须整齐无毛边。

 深圳市基克纳科技有限公司 Geekvape Technology co,LTD		绘图 PRODUCTNAME	魏鹏 2021/3/5	比例 SCALE 1:1
		审核 CHECKED		UNIT(单位) : mm REV(版本) : A1
未标公差 OTHER TOLERANEC	产品名称 PRODUCTNAME	Geekvape Z Max Tank - 说明书	核准 APPROVED	
	产品编码 PART NO	GA0001		
	产品图号 PART NO	GA0001-P-10		